

Synergy Telecom P Ltd.

Part No- ST02N24MF018

N MALE TO 2.4mm FEMALE ADPATOR

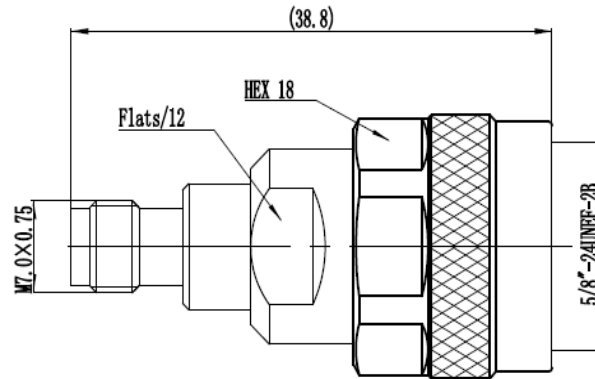

Tolerance +/- 2mm

Electrical:

Characteristic Impedance	50 ohm
Frequency Range	DC-18 Ghz
VSWR	$\leq 1.20 @ DC-18GHz$
Insertion Loss	≤ 0.3 dB
Dielectric withstanding Voltage	$\geq 1000V$ Vrms at Sea Level
RF high potential withstanding Voltage	$\geq 500V$ Vrms at 5Mhz
Insulation Resistance	≥ 3000 MOhm

Mechanical:

Durability	Mating Cycles ≥ 500
------------	--------------------------

Material and Plating:

	Material	Plating
Body	Stainless Steel	Polished & Passivated
Insulator	PEI	
Center conductor	Beryllium Copper	Gold

Environmental:

Operating Temperature Range	$-55^{\circ}C \sim +165^{\circ}C$
RoHs	Compliant

WZ-47 BUDHELLA VILLAGE ,VIKASPURI NEW DELHI-110018
Phone: 011-28533349, Mob: 9810138894/9212558066, Fax: 011-28533349
Email:- info@rfconnector.in, Website:- www.rfconnector.in